

ReSound Ve[™] ReSound Magna[™]

NON WIRELESS
BEHIND-THE-EAR (BTE)
RECEIVER-IN-THE-EAR (RIE)
USER GUIDE



ReSound



rediscover hearing

Introduction

Congratulations on the purchase of your new hearing instruments. ReSound's innovative sound technology and design, combined with the customised set-up selected by your hearing care professional, will make hearing a more enjoyable experience. Hearing instruments will enable you to hear sounds that you may not have heard in years because of your hearing loss. Practice and a positive attitude are important in learning to use hearing instruments. Your ReSound instruments have been adjusted according to your individual hearing loss and needs. Some people adjust quickly to wearing hearing instruments in their ears and hearing new sounds; other people may need more time.

Please read this manual carefully in order to wholly benefit from the use of your hearing instruments. With proper care, maintenance, and usage, your hearing instruments will aid you in better communication for many years. Ask your hearing care professional if you have any questions.

ReSound is a registered trade mark of GN ReSound A/S

Intended use

Generic air-conduction hearing instruments are wearable sound-amplifying devices intended to compensate for impaired hearing. The fundamental operating principle of hearing instruments is to receive, amplify, and transfer sound to the ear drum of a hearing impaired person.

Hearing instrument model: _____

Model	VE60	VE62	VE70	VE77	VE80	VE88	MG90
Battery size	312	312	13	13	13	13	675

Receiver tube length: _____ Tube type: _____ Dome size: _____

Left serial number: _____ Right serial number: _____

SYMBOLS



WARNING points out a situation that could lead to serious injuries,
CAUTION indicates a situation that could lead to minor and moderate injuries.



Advice and tips on how to handle your hearing instrument better.

CONTENTS

Introduction	2	Tele-loop systems	24
Description of the BTE hearing instruments	6	Direct audio input (optional)	24
Description of the RIE hearing instruments	10	Connecting/Disconnecting audio boots	25
Getting started.	12	Care and maintenance.	26
SmartStart.	12	Daily maintenance	27
Battery door lock	13	Maintenance for BTE hearing instruments	27
Inserting/Replacing the battery.	13	Cleaning earmoulds.	28
Low battery indicator	14	Cleaning thin tubes and domes	28
Inserting/Removing hearing instruments.	14	How to apply domes	29
Removal (custom earmolds)	16	Standard domes	29
Removal (domes)	16	Tulip domes	29
Operation of the hearing instrument	17	Maintenance for the RIE hearing instruments	30
Telephone use.	21	The receiver tube.	30
Telecoil (optional)	21	Cleaning the receiver tubes and domes	31
PhoneNow.	22	Cleaning RIE or moulds	31
		Changing wax guard for receiver tube	32

How to apply domes	33
Temperature test, transport and storage information	35
General precautions.	35
General warnings.	36
Battery warning information	37
Troubleshooting Guide	38
Troubleshooting Guide	40
Technical Data	42
Warranty and repairs	43

Description of the BTE hearing instruments

VE360-DI

VE370-DVI, VE270-DVI, VE170-VI

VE380-DVI, VE280-DVI, VE180-VI

MG490-DVI, MG290-DVI

1. Programme button
2. Battery compartment & On/Off switch
3. Sound outlet
4. Front microphone inlet
5. Back microphone inlet
6. Volume control (optional)
7. Direct audio input
8. Left/Right indicator
(Left=Blue/Right=Red)
9. Battery door lock
10. Model
11. Product name
12. Serial number
13. Battery door

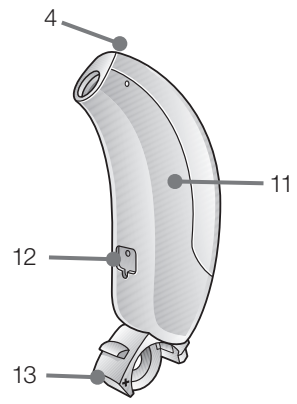
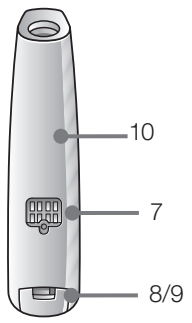
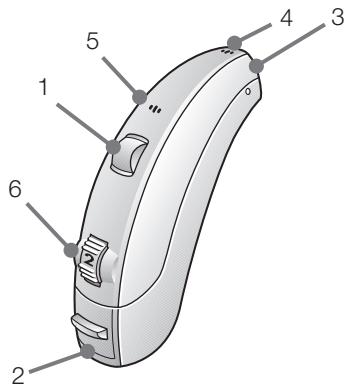

Description of the BTE hearing instruments

VE377-DVI, VE377-DVIO,VE388-DVI

1. Programme button
2. Battery compartment & On/Off switch
3. Sound outlet
4. Front microphone inlet
5. Back microphone inlet
6. Volume control (optional)
7. Direct audio input
8. Left/Right indicator (Left=Blue/
Right=Red)
9. Battery lock (optional)
10. Model
11. Manufacturer
12. Serial number
13. Earhook
14. Earmold and tubing
15. Thin Tube
16. Domes/earmold
 - a. Open dome
 - b. Tulip-Dome
 - c. Custom earmold
17. Sports lock (optional)

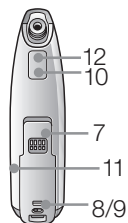
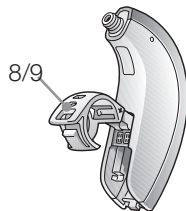
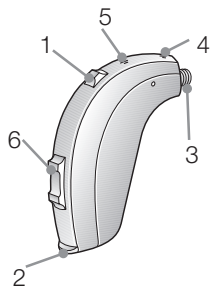

**Traditional fitting
(earmold and tube)**

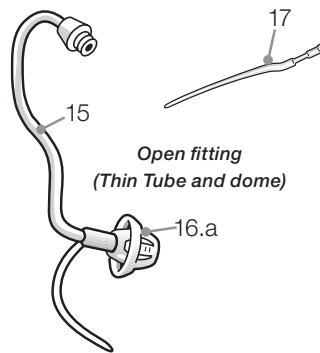
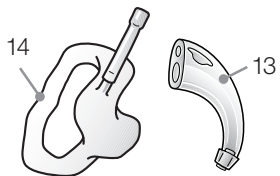

**Open fitting
(Thin Tube and dome)**

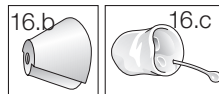

Description of the RIE hearing instruments

VE362-DVIR

1. Receiver tube
2. Receiver Open Dome
3. Receiver Tulip Dome
4. Receiver Power Dome
5. RIE mould
6. Sports lock
7. Battery compartment
8. Receiver
9. Push button
10. Volume Control (optional)
11. NP receiver tube
12. HP receiver tube
13. Left/right indicator
14. Model, and serial number
15. Direct audio input

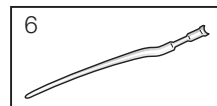
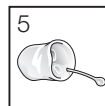
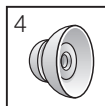
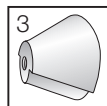
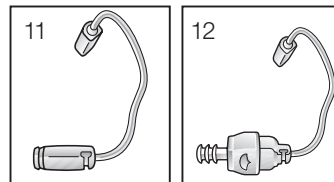

62 model
(type MRIE)

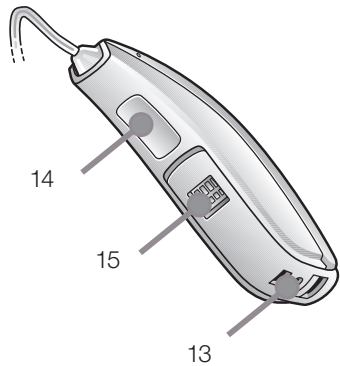
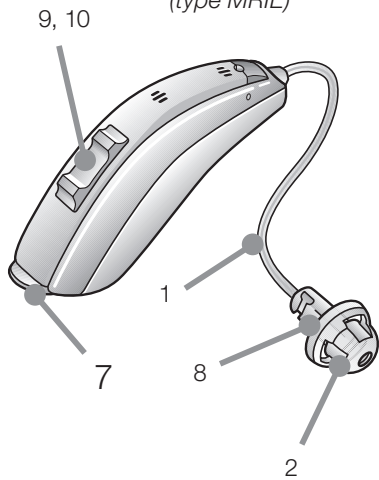

Getting started

On/Off function

1. When the battery door is closed, the hearing instrument turns on, and the default program will be activated.
2. To turn off the hearing instrument, open the battery door. Many individuals can use their fingernail to pull it open.



Tip: Whenever the hearing instruments are not in use, remember to turn them off to avoid unnecessary battery consumption.

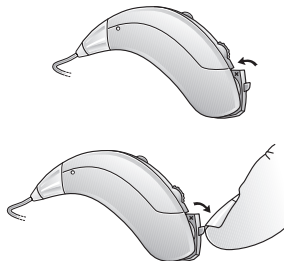

SmartStart

Hearing instruments can be turned on once you have placed them on your ears. If you prefer to turn them on just prior to placing them on your ear, your hearing care professional can activate a function called SmartStart.

This function will delay the time in which the hearing instruments turn on by ten seconds after the battery compartment is closed. This reduces the risk that the hearing instruments will whistle while you put them on. With SmartStart, a beep will be heard for each second of the delay period.

Battery door lock

Your hearing care professional can install a Left/Right side indicator (Blue=Left, Red=Right), which can be used to lock the battery door. Once locked, the instrument can only be turned off once the instrument is unlocked.

To lock the battery door:

1. Close the battery door
2. Using the battery door locking tool, slide the color marker to the right.

To unlock the battery door: Slide the color marker to the left.

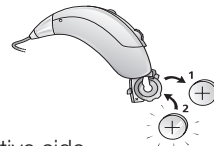
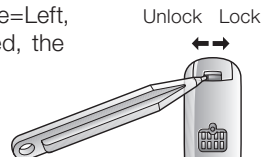

Inserting/Replacing the battery

1. Open the battery door completely by using your fingernail.
2. Remove the used battery if present. Insert the new battery with the positive side in the correct position. The battery door has a '+' indicator to help determine the correct insertion.
3. Always use new Zinc-Air batteries that have a minimum remaining shelf-life of 1 year.
4. Gently close the battery door.



Tip: When the hearing instruments are not in use for an extended period of time, removing the batteries may help prevent corrosion of the battery compartment, and ensure that battery life is not shortened.

Low battery indicator

Your hearing care professional can set your hearing instrument to give an acoustical indication when the battery is reaching its end of life. The hearing instrument will reduce amplification and emit a melody if battery power gets too low. This signal will recur every 5 minutes for VE60/62/70/77/80/88 models, and every 15 minutes for MG90, until the hearing instrument automatically switches off. It is recommended that you keep spare batteries on hand.

Inserting/Removing hearing instruments

Insertion (custom earmoulds)

1. Hold the earmould between your thumb and index finger and position its sound outlet in your ear canal.
2. Slide the earmould all the way into your ear with a gentle, twisting movement.
3. Turn the top part of the earmould gently backwards and forwards so that it tucks behind the fold of skin above your ear canal.
4. Move the earmould up and down and gently press to ensure it is positioned correctly in the ear. Opening and closing your mouth can ease insertion.
5. Make sure the hearing instrument is seated behind the ear.



By experimenting, an easier method may be discovered. With proper insertion, hearing instruments should fit snugly but comfortably. If hearing instruments cause irritation of the ears, contact your hearing care professional. Never attempt to modify the shape of the hearing instrument, earmoulds, or tubing yourself.



Tip: It may be helpful to pull your ear up and outward with your opposite hand during insertion.

Insertion (domes)

1. Hold the thin tube where it bends, and gently push the dome into the ear canal. Push the dome far enough into the ear canal so that the thin tube lies flush with the head.
2. It is important that the tube and the dome fit correctly into your ear.
3. When the dome is placed correctly, you should not be able to see the thin tube sticking out when facing a mirror.

Note: You should never attempt to bend or modify the shape of the thin tube.

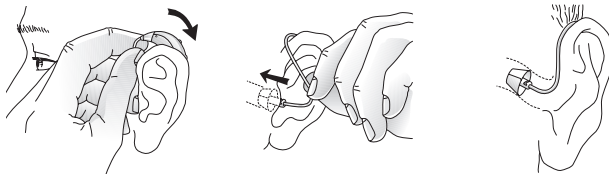

Removal (custom earmolds)

1. Hold a portion of your earmould towards the back of the ear.
2. Pull the earmould outward and simultaneously rotate the earmould forward.
3. Consult your hearing care professional if you have difficulties removing the hearing instrument.

Removal (domes)

1. Hold the thin tube with your thumb and forefinger and pull the tube outward.
2. Consult your hearing care professional if you have difficulties removing the hearing instrument.

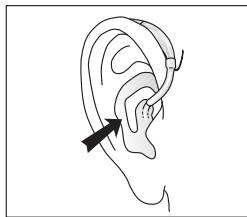

Operation of the hearing instrument

Volume control (in 70, 80, and 90 models)

The volume wheel has numbers on it from 1 to 4, with 4 being the maximum volume setting. During the fitting of the hearing instrument, your hearing care practitioner will select an optimal volume setting for you. Please note the setting of that particular level. To increase the volume with the instrument fit to your ear, turn the volume control wheel up. To reduce the volume, turn the wheel down.

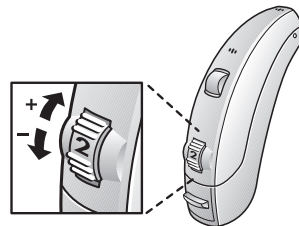

Please note that your instrument has been fit by your hearing care professional and that your hearing loss requires a certain amount of amplification. This will also affect how much you are able to increase the volume on your instrument. If you want to go back to the default volume setting, the volume control has to be set at 2,5 (between 2 and 3). If you prefer not to use the volume wheel your hearing care practitioner can disable the volume control.

Sports lock

The Sports lock will be applied or adjusted by your hearing care professional.

Volume control (in 62, 77, 88 models)

The volume control will allow the volume of hearing instruments to be increased or decreased.

1. To increase the volume, push the volume control up.
2. To decrease the volume, push the volume control down.

When volume is increased or decreased, a beep signal will be heard for each incremental change. When the upper or lower limits of the volume range are reached, a beep signal with a longer duration will be heard.

Your hearing care professional can disable the volume control function if it is not desired. The volume control can also be replaced with a non-functional cover.

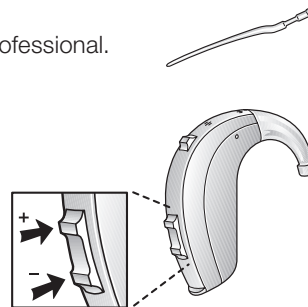

Programme button

Depending on your experience level with hearing instruments, individual hearing needs, and the type of listening environments you experience, your hearing care professional may activate additional programmes. If additional programmes have been activated, the following list explains how they work.



1. You can switch between programmes by pushing the programme button once.
2. You will then hear one or more beeps. The number of beeps indicates which programme you have selected (one beep = programme one, two beeps = programme two, etc.).
3. When the hearing instruments are turned off and then back on, the hearing instrument always returns to the default setting (programme one).

The multifunction button (62 models only) is designed to change the volume or listening programs of the hearing instrument, based on different ways it is pressed.

If necessary, your hearing care practitioner can change these settings and fill in the following table to indicate new settings

Multi-function button action	Default setting	New setting
Short press up	Increases volume	
Short press down	Decreases volume	
Long press up (3 seconds)	Changes programs	

Programme	Description of when to use
1	
2	
3	
4	

Telephone use

Finding the optimal position for holding a telephone may require practice for some individuals, and one or more of the following suggestions may be helpful.

1. Hold the telephone as you would normally.
2. Hold the telephone towards the top of the ear (closer to where the microphones are).
3. If whistling occurs, it may take a few seconds of holding the telephone in the same position before the hearing instrument adapts.
4. Any whistling may also be decreased by holding the telephone slightly away from the ear.
5. Depending on your individual needs, your hearing care professional may activate a programme specifically for telephone use.



Telecoil (optional)

If needed, a telecoil can be activated by your hearing care professional and accessed through one of the additional programmes. A telecoil picks up a telephone's magnetic signal and converts it to sound. When using a telecoil programme, the receiver of the telephone may need to be held closer to the hearing instrument. The handset of the telephone may need to be moved to slightly different positions in order to find the best reception.

PhoneNow

The PhoneNow function, available on some hearing instrument models, allows your hearing instrument to automatically switch to your telephone program when a telephone receiver is raised to the ear. When the telephone receiver is removed from the ear, the hearing instrument automatically returns to the previous listening program.

Placement of PhoneNow magnets

While some telephone receivers produce a magnetic field strong enough to activate the Phone Now function, other telephone receivers require an additional magnet to be placed on the telephone receiver. In order to place the PhoneNow magnet properly:

1. Clean the telephone receiver thoroughly.
2. Hold the telephone vertically, in a position similar to when making a telephone call.
3. Place the magnet just below the telephone receiver. If necessary, move the magnet to another position to improve ease of use and comfort while speaking.

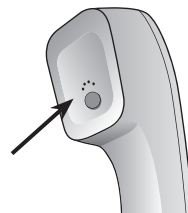

Tip: Use only recommended cleaning agent to clean the telephone prior to placing the magnet on the phone in order to obtain best possible adherence.

PhoneNow usage

Telephones can be used in a normal manner. A beep signal will indicate that the PhoneNow feature has automatically switched the hearing instrument to your telephone program. Initially, you may need to move the telephone receiver slightly to find the best position for reliable PhoneNow activation and good hearing on the telephone.



PhoneNow warnings

1. Keep magnets out of reach of pets, children and mentally challenged persons. If a magnet is swallowed, please seek advice from a medical practitioner.
2. The magnet used to supplement the magnetic field of a telephone receiver may affect some medical devices or electronic systems. The manufacturer of any magnetically sensitive devices (e.g. pacemakers) should advise you regarding appropriate safety precautions when using your hearing instrument and magnet in close proximity to the medical device or electronic system in question.

If the manufacturer cannot issue a statement, we recommend keeping the magnet or a telephone equipped with the magnet 30 cm (12") away from magnetically sensitive devices (e.g. pacemakers).



PhoneNow Precautions

1. High distortion during dialing or phoning may mean that the magnet is not in the optimal position relative to the telephone receiver. To avoid the issue, please move the magnet to another place on the telephone receiver.
2. Only use magnets supplied by GN ReSound.

Tele-loop systems

Many places, such as theatres, houses of worship, and schools are equipped with tele-loop systems. When using a telecoil programme with tele-loop systems, sound is picked up directly. If there is no sound from the hearing instruments in a tele-loop system and with a telecoil programme activated, the tele-loop system may not be turned on or is not operating correctly. If a facility is not equipped with a tele-loop system, sitting as close as possible to the front may be helpful.

Direct audio input (optional)

Use of direct audio input (DAI), which enables a direct connection of the hearing instruments to items such as television, radio, and remote microphones, may increase speech understanding for some individuals. The sound source is connected to the hearing instruments by a cable or a wireless FM system to the audio boot. This accessory connects to the bottom of the hearing instruments, and once properly clicked into place, the hearing instruments switch to DAI automatically.

Connecting/Disconnecting audio boots

Connecting audio boots

1. Align the tip of the audio boot with the groove just above the battery compartment and below the model number.
2. Once in place, move the boot in the direction of the battery compartment.
3. Gently click the audio boot onto the hearing instrument.

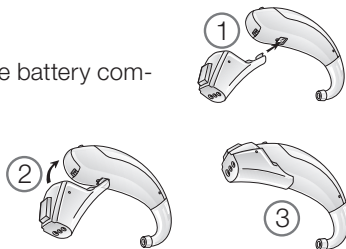

Disconnecting audio boots

1. Press and hold the button on the front side of the audio booth.
2. Gently remove the audio boot from the hearing instrument.

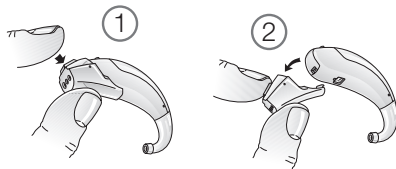

Care and maintenance

Please follow the following instructions to prolong the durability of your hearing instruments:

1. Keep your hearing instrument clean and dry. Wipe the case with a soft cloth or tissue after use to remove grease or moisture. Do not use water or solvents, as these can damage the hearing instrument(s).
2. Never immerse hearing instruments in water or other liquids, as liquids may cause permanent damage to the hearing instruments.
3. Avoid rough handling of hearing instruments or dropping them on hard surfaces or floors.
4. Do not leave hearing instruments in or near direct heat or sunlight, such as in a hot, parked car, as excessive heat can cause damage or deform the casing.
5. Do not wear your instrument while showering, swimming, in heavy rain or in a moist atmosphere such as a steam bath or sauna.
6. If your instrument does get wet, or if it has been exposed to high humidity or perspiration, it should be left to dry out overnight with the battery out and the battery compartment open. It is also a good idea to put the instrument and battery in a sealed container together with a drying agent (desiccator) overnight. Do not use the instrument until it is completely dry. Consult your hearing care professional as to which drying agent to use.

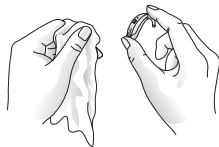

7. Remove your hearing instrument when applying such things as cosmetics, perfume, aftershave, hair spray, and suntan lotion. These might get into the instrument and cause damage.

Daily maintenance

It is important to keep your hearing instrument clean and dry. On a daily basis, clean the hearing instruments using a soft cloth or tissue. In order to avoid damage due to humidity or excessive perspiration, the use of a drying kit is recommended. Some drying kits are electric, and in addition to thoroughly drying out hearing instruments, they help sanitize.

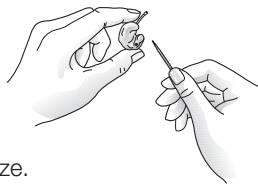

Maintenance for BTE hearing instruments

(in 60, 70, 77, 80, 88 and 90 models)

i Cleaning earmoulds

1. Remove the earmould and attached tubing from the hearing instruments prior to cleaning.
2. Clean the earmould using a mild soap, and rinse with lukewarm water.
3. After cleaning, dry earmoulds thoroughly and remove any residual water and debris from the tubing utilising an air bulb and wire loop.

Note: Earmould tubing may become stiff, brittle, or discoloured over time. Contact your hearing care professional regarding tube changes.



i Cleaning thin tubes and domes

1. Remove thin tubes from hearing instruments before cleaning by unscrewing them counter clockwise.
2. Wipe down thin tubes and domes with a damp cloth.
3. In order to clear the thin tube of moisture and debris, push the black cleaning rod through the thin tube, beginning at the end opposite the dome.

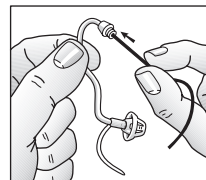

Note: Thin tube and dome systems should be changed every three months or sooner, should the components become stiff or brittle.

How to apply domes

It is recommended that your hearing care professional change domes, as incorrect dome replacement could result in injury.

Standard domes

1. Push the new dome over the flanges on the thin tube.
2. Make sure that the new dome is properly and securely mounted.

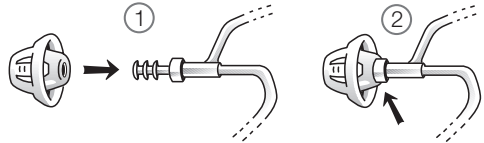

Tulip domes

Tulip domes are mounted in a similar manner to standard domes, but a few extra steps are required. Tulip domes consist of two “petals”. It is important to note that the largest petal is the outermost petal. To ensure this:

1. Push the largest petal away from the thin tube using a finger. This bends the petal forward.
2. Then push the largest “petal” back, and it will be placed on top of the smaller petal.

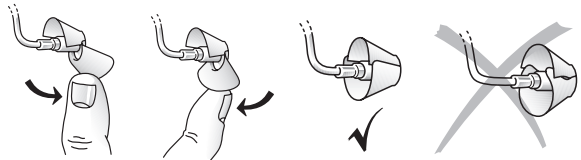

Maintenance for the RIE hearing instruments

(in 62 models)

The receiver tube

The receiver tube contains the wiring to the receiver which delivers the sound to the ear canal. It is important that the receiver tube and the receiver dome/RIE mold fits correctly in your ear. If the receiver tube or the receiver dome/RIE mould irritates your ear in any way and prevents you from wearing your hearing instrument, please contact your hearing care professional. You should never attempt to modify the shape of the receiver tube yourself. The receiver tube and the receiver dome/RIE mould should be cleaned regularly. Please see instructions in the next section.

i **Cleaning the receiver tubes and domes**

The receiver tube and the receiver dome should be cleaned regularly. Use a damp cloth to clean the receiver tube and receiver dome on the outside. Do not use water when you are cleaning the receiver tubes or the receiver domes. This process is also used to clean the UP receiver mould. Please see instruction on page 30 or 31 for how to change the wax guard filter.

i **Cleaning RIE or moulds**

1. Separate the mould from the receiver tube.
2. Clean the RIE mould using a mild soap, and rinse with lukewarm water.
3. After cleaning, dry RIE moulds thoroughly and remove any residual water and debris from the tubing utilising an air bulb and wire loop.

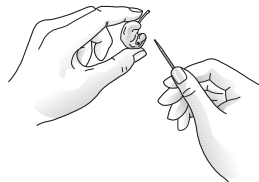

Changing wax guard for receiver tube

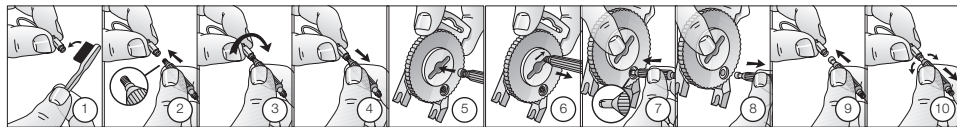

For NP receivers:

1. Clean any debris from the old waxguard.
2. Insert the wand into the old waxguard.
3. Twist the wand with the waxguard in a clockwise direction to ensure it is attached to the wand.
4. Pull the wand and waxguard away from the tube/mould.
5. Insert the old waxguard into the center of the HF3 wheel.
6. Dispose of the old waxguard by drawing the wand to the narrow end of the center disposal area.
7. Insert the empty wand into a new waxguard on the HF3 wheel.
8. Pull the new waxguard attached to the wand away from the HF3 wheel.
9. Insert the wand into the receiver tube/mould.
10. Twist the wand to release the new waxguard onto the receiver tube/mould.

HP receivers:

1. To remove the old wax guard, insert the removal side of the wax guard tool into the used wax guard so that the shaft of the tool is touching the rim of the wax guard. Slowly pull the wax guard straight out.
2. To insert the new wax guard, gently press the replacement side of the wax guard tool straight into the hole of the sound outlet until the outer ring lies flush with the outside of the receiver. Pull the tool straight out -the new wax guard will remain in place.

How to apply domes

It is recommended that your hearing care professional change domes, as incorrect dome replacement could result in injury.

ReSound standard domes

1. Push the new dome over the receiver.
2. Make sure that the new dome is properly and securely mounted.

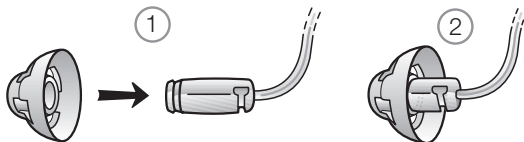

ReSound tulip domes

Tulip domes are mounted in a similar manner to standard domes, but a few extra steps are required. Tulip domes consist of two “petals”. It is important to note that the largest petal is the outermost petal. To ensure this:

1. Push the largest petal away from the receiver tube using a finger. This bends the petal forward.
2. Then push the largest “petal” back, and it will be placed on top of the smaller petal.

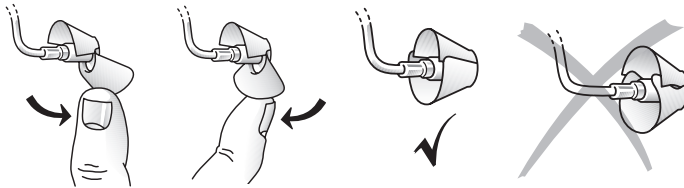

Temperature test, transport and storage information

GN ReSound Hearing Instruments are subjected to various tests in temperature and damp heating cycling between -25°C (-13°F) and $+70^{\circ}\text{C}$ ($+158^{\circ}\text{F}$) according to internal and industry standards. During transport or storage, the temperature should not exceed the limit values of -20°C (-4°F) to $+60^{\circ}\text{C}$ ($+140^{\circ}\text{F}$) and relative humidity of 90% RH, non-condensing (for limited time). The air pressure between 500 and 1100 hPa is appropriate.



General precautions

1. Do not leave hearing instruments in the sun, near an open fire, or in a hot, parked car.
2. Do not wear hearing instruments while showering, swimming, in heavy rain, or in a moist atmosphere such as a steam bath or sauna.
3. Should the hearing instrument become moist, remove the battery and place the hearing instrument in a closed container with a drying agent. Your hearing care professional can provide options for drying containers or kits.
4. Remove the hearing instruments when applying items such as cosmetics, perfume, after-shave, hair spray, and suntan lotion.
5. Use only original ReSound consumables e.g. tubes and domes.
6. Only connect ReSound hearing instruments to ReSound accessories intended and qualified to be used with ReSound hearing instruments.
7. Never attempt to modify the shape of the hearing instrument, ear-moulds, or tubing yourself.



General warnings

1. If the device is broken, do not use.
2. Consult a hearing care professional if you discover a foreign object in your ear canal, if you experience skin irritation, or if excessive ear wax accumulates with the use of the hearing instrument.
3. Different types of radiation, from e.g. NMR, MRI, or CT scanners, may damage hearing instruments. It is recommended not to wear hearing instruments during these or other similar procedures. Other types of radiation, such as burglar alarms, room surveillance systems, radio equipment, mobile telephones, contain less energy and will not damage hearing instruments. However, they have the potential to momentarily affect the sound quality or temporarily create strange sounds from hearing instruments.
4. Do not wear hearing instruments in mines, oil fields, or other explosive areas unless those areas are certified for hearing instrument use.
5. Do not allow others to use your hearing instruments. This may cause damage to the hearing instruments or to the hearing of the other individual.
6. Instrument usage by children or mentally challenged persons should be supervised at all times to ensure their safety. The hearing instrument contains small parts that could be swallowed by children. Please be mindful not to leave children unsupervised with this hearing instrument.
7. Hearing instruments should be used only as prescribed by your hearing care professional. Incorrect use may result in hearing loss.

8. Warning to hearing care professionals: Special care should be exercised in selecting and fitting hearing instruments with maximum sound pressure level that exceeds 132dB SPL with an IEC 60711:1981 occluded ear simulator. There may be a risk of impairment of the remaining hearing.
9. External devices connected to the electrical input must be safe according to the requirements of IEC 60601-1-1, IEC 60065, or IEC 60950-1, as appropriate.



Battery warning information

1. Do not put batteries in your mouth, as they can be harmful if swallowed. If swallowed, seek medical help immediately.
2. Keep batteries away from children and mentally challenged persons.
3. Remove the batteries to prevent leakage when the hearing instruments are not in use for an extended period of time.
4. Do not attempt to recharge batteries (Zinc Air) which are not specifically designated as rechargeable because they may leak or explode.
5. Do not attempt to dispose of batteries by burning them.
6. Used batteries are harmful to the environment. Please dispose of them according to local regulations or return them to your hearing care practitioner.

Troubleshooting Guide

SYMPTOM	CAUSE
No sound	<ul style="list-style-type: none">• Not turned on• Dead battery• Battery door will not close• Blocked earmould or tube
Not loud enough	<ul style="list-style-type: none">• Incorrect earmould placement• Blocked earmould or dome• Blocked sound outlet filter• Change in hearing sensitivity• Excessive ear wax• Volume set too low

POSSIBLE REMEDY

- Turn on by closing the battery door
 - Replace battery
 - Insert battery properly
 - Clean earmould or tube
-
- Reinsert earmould
 - Clean earmould, replace dome, replace filter
 - Change filter or consult your hearing care professional
 - Consult your hearing care professional
 - Consult your physician
 - Increase the volume control if available or consult your hearing care professional
-

Troubleshooting Guide

SYMPTOM	CAUSE
Excessive whistling / feedback	<ul style="list-style-type: none">• Incorrect earmould placement• Incorrect dome placement• Excessive ear wax• Feedback control may need adjustment• Earmould tubing worn or damaged• Thin tube connection loose• Hearing instrument settings not optimal
Sound distorted / not clear	<ul style="list-style-type: none">• Weak battery• Improper earmould or dome fit• Hearing instrument damaged• Hearing instrument settings not optimal

POSSIBLE REMEDY

- Re-insert earmould carefully
- Re-insert dome
- Consult your hearing care professional
- Consult your hearing care professional
- Consult your hearing care professional
- Change thin tube or consult your hearing care professional
- Consult your hearing care professional

-
- Replace battery
 - Consult your hearing care professional
 - Consult your hearing care professional
 - Consult your hearing care professional
-

If there are any other problems not mentioned in this guide, please contact your hearing care professional.

Technical Data

Hearing Instrument Model	Maximum output (2ccCoupler / IEC 60118-7)
RIE	
VE362-DVIR NP	114 dB SPL
VE362-DVIR HP	117 dB SPL
BTE Standard tube	
VE360-DI	123 dB SPL
VE370-DVI, VE270-DVI, VE170-VI	128 dB SPL
VE377-DVI	127 dB SPL
VE380-DVI, VE280-DVI, VE180-VI	136 dB SPL
MG490-DVI, MG290-DVI	139 dB SPL
VE388-DVI	130 dB SPL
BTE thin tube	
VE360-DI	125 dB SPL
VE370-DVI, VE270-DVI, VE170-VI	126 dB SPL
VE377-DVI	123dB SPL

Warranty and repairs

ReSound provides a warranty on hearing instruments in the event of defects in workmanship or materials, as described in applicable warranty documentation. In its service policy, ReSound pledges to secure functionality at least equivalent to the original hearing instrument. As a signatory to the United Nations Global Compact initiative, ReSound is committed to doing this in line with environment-friendly best practices. Hearing instruments therefore, at ReSound discretion, may be replaced by new products or products manufactured from new or serviceable used parts, or repaired using new or refurbished replacement parts. The warranty period of hearing instruments is designated on your warranty card, which is provided by your hearing care professional.

For hearing instruments that require service, please contact your hearing care professional for assistance. ReSound hearing instruments that malfunction must be repaired by a ReSound qualified technician. Do not attempt to open the case of hearing instruments, as this will invalidate the warranty.



Please ask your local hearing care professional concerning disposal of your hearing instrument

Worldwide Headquarters

ReSound A/S
Lautrupbjerg 7
DK-2750 Ballerup, Denmark
Tel.: +45 45 75 11 11
Fax: +45 45 75 11 19
www.resound.com
CVR no. 55082715

United Kingdom

GN ReSound Ltd.
Kirtlington Business Centre
Portway
Kirtlington
Oxon OX5 3JA
Tel.: +44 1869 352 800
Fax: +44 1869 343 466
www.gnresound.co.uk

Australia

GN ReSound Pty. Ltd.
Unit R1 Regents Park Estate
391 Park Road
Regents Park NSW 2143
Tel.: (free) 1800 658 955
Fax: +61 2 9743 7472
www.gnresound.com.au

New Zealand

GN ReSound (NZ) Ltd.
Ground Floor, North Entrance
4 Fred Thomas Drive
Takapuna
Auckland, 0622
Tel.: (free) 0800 900 126
Fax: (free) 0800 007 695
www.gnresound.co.nz



*Any issues relating to the EU Medical Device Directive
93/42/EEC should be directed to ReSound A/S.*

ReSound

rediscover hearing